

#8005452

42" CONDUCTOR SLEEVE TO FIT S150 HYDRAULIC HAMMER

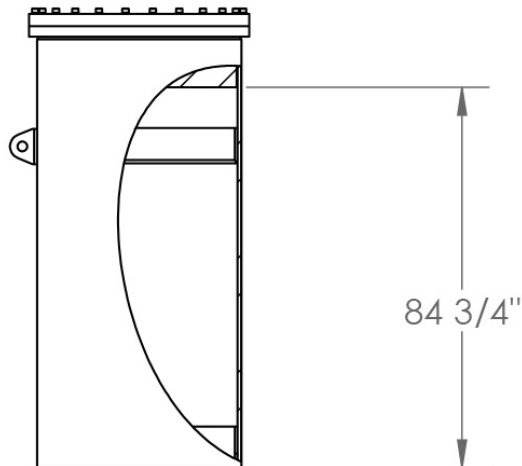
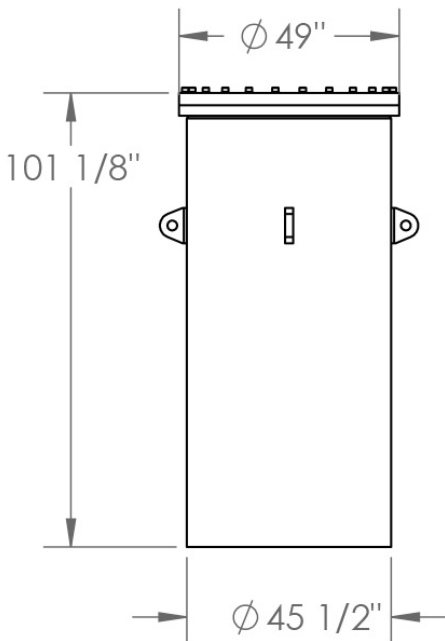
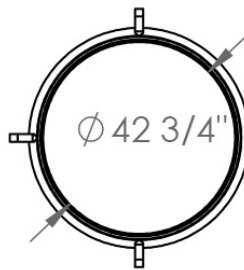
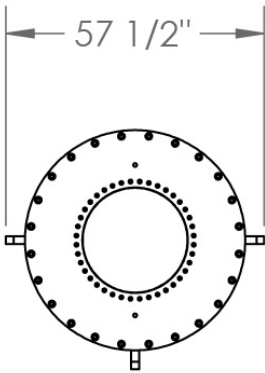

#8005452

Weight: 9,480 lbs.