

#8001974

30" CONDUCTOR SLEEVE TO FIT S150 HYDRAULIC HAMMER

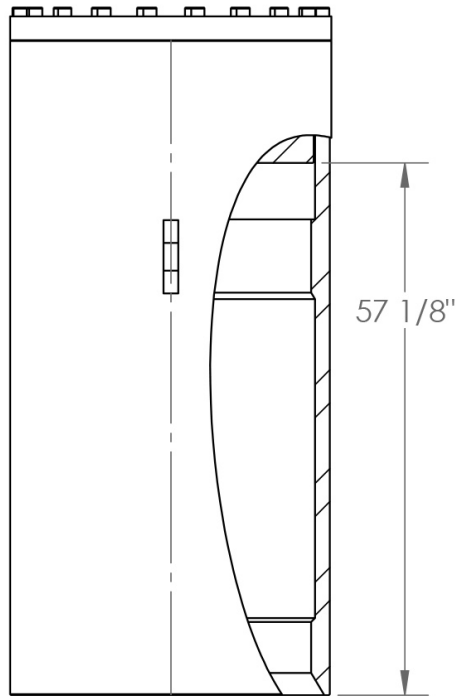
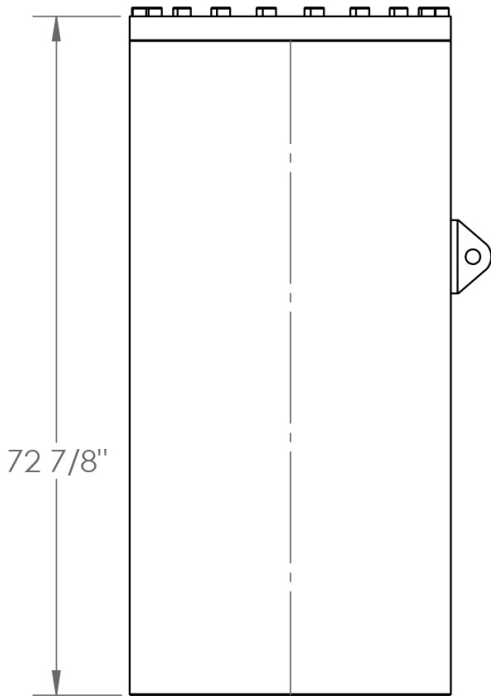
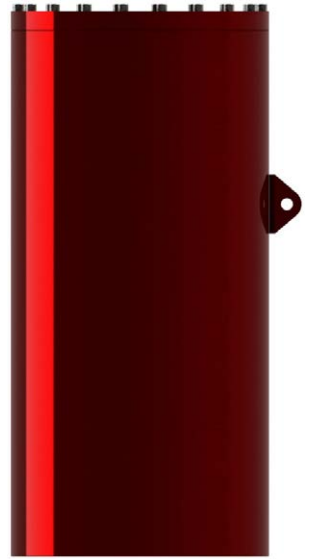
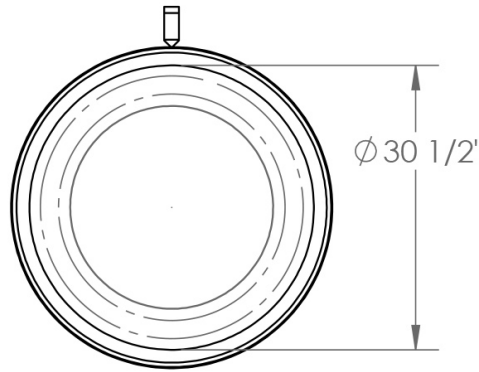
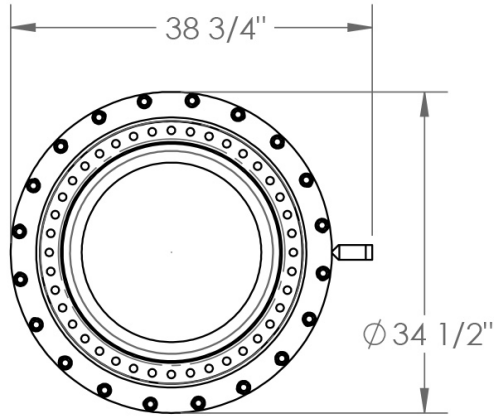

#8001974

Weight: 5,688 lbs.