

Helmets

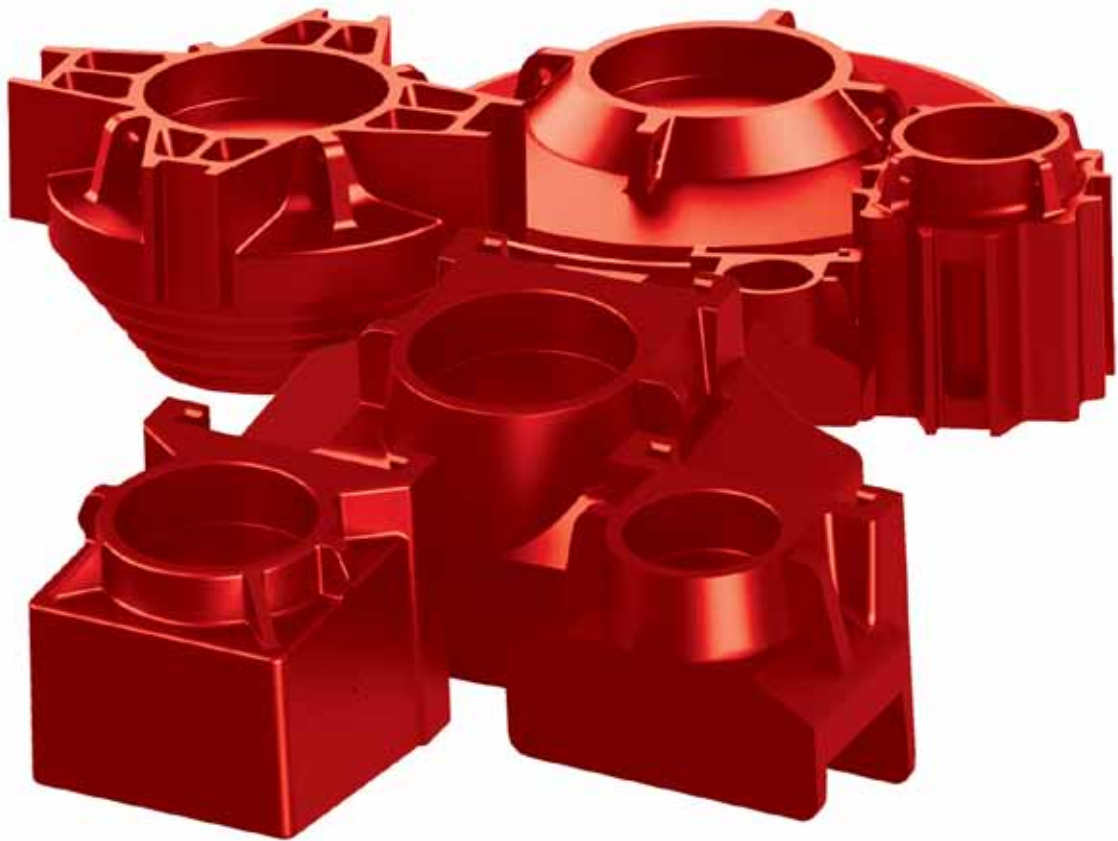

Primary Helmet Assembly Diagram	3
Primary Helmet Assembly	4
Helmet Inserts	5
Offshore Helmet Assembly	6–7
Neck Adapters	8
Follower	9
Square Concrete Helmet Assembly	10
Universal Helmet Assembly	11
EU Helmets Assembly	12–13

General Layout of the 21" Primary Assembly

***Larger Assemblies require cushion variations**

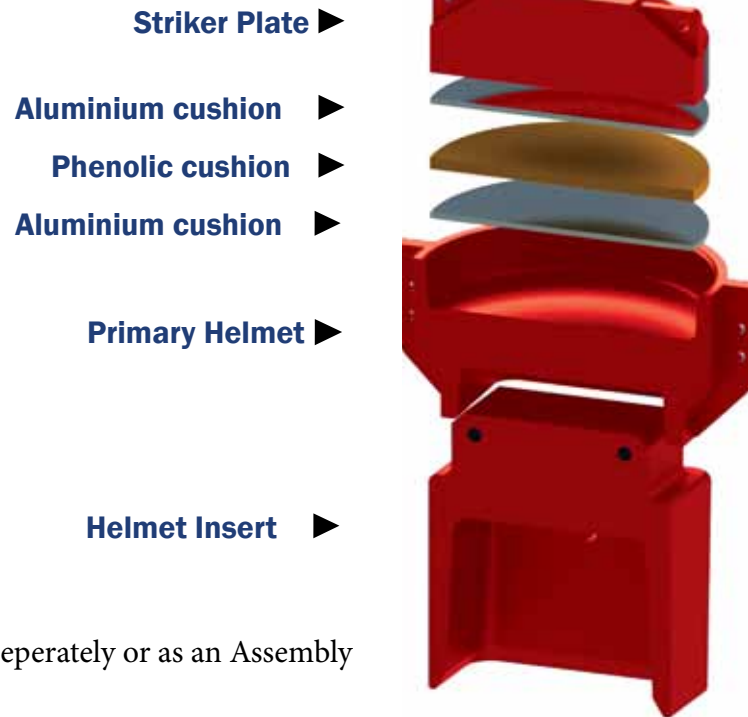





*Items are sold seperately or as an Assembly



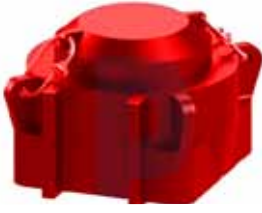

Striker Plate	For Delivery of Impact
	Striker plate is for the delivery of energy from the impact of the hammer to the helmet assembly.
Hammer Cushion	For Diesel hammer and Helmet Protection
	1" Micarta & 2 x 1/2" Aluminium <ul style="list-style-type: none"> • modulus of elasticity: 350 ksi • coefficient of restitution: 0.8
Primary Helmet	Features
	<ul style="list-style-type: none"> • machined bottom receptacle for cushion and helmet insert for maximum energy transfer and lifetime • 17" standard square for inserts • integrated U-lead guiding
Helmet Insert	Features
	<ul style="list-style-type: none"> • machined face of 17" square for max. energy transfer • inserts for concrete, steelpipe, sheet and h-piles available



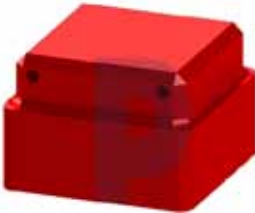
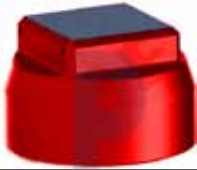

Primary Helmet Assembly

All weights are approximated

P-500 21" Primary Helmet					
	#	Assembly	Qty	Weights lbs.	Accessories
	500521	Primary Helmet	1	1050	steel cable 2
	500307	Striker Plate Ø 17"x6"	1	330	cable clamp 2
	500157	aluminium cushion Ø 17"x1/2"	2	22(for 2)	
	500107	phenolic cushion Ø 17"x1"	1	12	
U-Lead Guiding: 21" x 8"				Total approx. weight= 1,414 lbs	
P-501 26" Primary Helmet					
	500526	Primary Helmet	1	2200	steel cable 2
	500309HD	Striker Plate Ø 23"x8"	1	798	cable clamp 2
	500159	aluminium cushion Ø 23"x1/2"	2	42 (for 2)	
	500109	phenolic cushion Ø 23"x1"	1	28	
U-Lead Guiding: 26" x 8"				Total approx. weight= 3,068 lbs	
P-503 32" Primary Helmet					
	500532	Primary Helmet	1	2750	steel clamp 2
	500309HD	Striker Plate Ø 23"x8"	1	798	cable clamp 2
	500159	aluminium cushion Ø 23"x1/2"	2	42 (for 2)	
	500109	phenolic cushion Ø 23"x1"	1	28	
U-Lead Guiding: 26" x 8", 32" x 8"				Total approx. weight= 3,618 lbs	
P-504 32" HD Primary Helmet					
	500532 HD	Primary Helmet	1	2820	steel cable 2
	500315	Striker Plate Ø 23"x10"	1	974	cable clamp 2
	500159	aluminium cushion Ø 23"x1/2"	3	63 (for 3)	
	500109	phenolic cushion Ø 23"x1"	2	56 (for 2)	
U-Lead Guiding: 32" x 8"				Total approx. weight= 3,913 lbs	
P-507 42" Primary Helmet					
	500542	Primary Helmet	1	5400	steel cable 2
	500315	Striker Plate Ø 23"x10"	1	974	cable clamp 2
	500159	aluminium cushion Ø 23"x1/2"	3	63 (for 3)	
	500109	phenolic cushion Ø 23"x1"	2	56 (for 2)	
U-Lead Guiding: 42" x 8", 36" x 8"				Total approx. weight= 6,493 lbs	

All weights are approximated

	Inserts For Concrete Piles				
	500512	12" Square	1,120 lbs approx.		
	500514	14" Square	1,170 lbs approx.		
	500516	16" Square	1,570 lbs approx.		
	500516-L	16" Square Long	1,600 lbs approx.		
	500518	18" Square	1,715 lbs approx.		
	500518-L	18" Square Long	1,800 lbs approx.		
500520	20" Square	1,724 lbs approx.			
	Inserts For H-Piles				
	500515	10", 12", 14" H-pile	890 lbs approx.		
	500518-H	16" , 18"	1,884 lbs approx.		
	500515-AR	HANDLES 14" HP BEAM UP TO 117	1,507 lbs approx.		
	Inserts For Pipe-Piles				
	500508-C	up to 16" Ø	760 lbs approx.		
	500509-1	up to 24" Ø	1,380 lbs approx.		
	500509-2	up to 30" Ø	2,210 lbs approx.		
	Inserts For Sheet				
		Length	Width	min. U-lead	Weight
	500513	30.5"	13.5"	26.5" x 8"	870 lbs approx.
	500513-2	38"	16.5"	32.5" x 8"	2,600 lbs approx.
	500513-4A	43"/39"	19.6"	32.5" x 8"	2,600 lbs approx.
	500513-5	51"	19"	42.5" x 8"	3,550 lbs approx.
	Inserts For Timber-Piles				
	500506-1	up to 12" Ø	560 lbs approx.		

P-514 36" OFFSHORE MALE TYPE HELMET ASSEMBLY					
	#	Assembly	Qty	Weights lbs. approx.	Accessories
	410455	Male type Offshore Helmet	1	6,300	steel cable 2
	500315	striker plate, Ø 23"x10"	1	974	(910-CBCP-12MM) cable clamp 2
	500159	aluminium cushion, Ø 23"x1/2"	3	63 (for 3)	
	500109	phenolic cushion, Ø 23"x1"	2	56 (for 2)	
				Total: 7,393 lbs	
Pipe Pile Size: 16"x 1", 20"x 1" 24"x 1-1/2", 30"x 1-1/2", 36"x 1-1/2" U-Lead Size: 36.5" x 8", 42.5" x 8"					
P-515 48" OFFSHORE MALE TYPE HELMET ASSEMBLY					
	410452	Male type Offshore Helmet	1	14,400	steel cable 2
	500330	striker plate, Ø 27"x12"	1	1,532	(910-CBCP-12MM) cable clamp 2
	500160	aluminium cushion, Ø 27"x1/2"	3	84 (for 3)	
	500110	phenolic cushion, Ø 27"x1"	2	76 (for 2)	
					Total: 16,092 lbs
Pipe Pile Size: 24" x 1", 30" x 1", 36" x 2" , 42" x 2", 48" x 2" U-Lead Size: 48.5" x 8", 54.5" x 8"					
P-516 66" OFFSHORE MALE TYPE HELMET ASSEMBLY					
	410453	Male type Offshore Helmet	1	26,600	steel cable 2
	500335	striker plate, Ø 37"x 12"	1	3,080	(910-CBCP-12MM) cable clamp 2
	500165	aluminium cushion, Ø 37"x 1/2"	3	159 (for 3)	
	500115	phenolic cushion, Ø 37"x 1"	2	142 (for 2)	
					Total: 29,981 lbs
Pipe Pile Size: 42" x 1-1/2", 48" x 1-1/2", 54" x 1-1/2", 60" x 1-1/2", 66" x 1-1/2" U-Lead Size: 66.5"x 8", 68.5"x 12"					
P-519 54" ROUND CONCRETE CYLINDER (SOLID CAP) HELMET ASSEMBLY					
	25081	54" Round Concrete Solid Cap	1	26,017	steel cable 2
	500335	striker plate, Ø 37" x 12"	1	3,080	(910-CBCP-12MM) cable clamp 2
	500165	aluminium cushion, Ø 37" x 1/2"	3	159 (for 3)	
	500115	phenolic cushion, Ø 37" x 1"	2	142 (for 2)	
					Total: 29,398 lbs
Concrete Cylinder Pile Size: 54"			U-Lead Size: 66.5"x 8"		

All weights are approximated

P-517 98" LARGE DIAMETER DRIVE PLATES					
	410454	98" Drive Plates Diameter	1	38,400	steel cable 2
	500335	striker plate, Ø 37" x 12"	1	3,080	(910-CBCP-12MM) cable clamp 2
	500165	aluminium cushion, Ø 37" x 1/2"	3	159 (for 3)	
	500115	phenolic cushion, Ø 37" x 1"	2	142 (for 2)	
					Total: 41,781 lbs
Pipe Pile Size: Up to 98-1/2"Ø , Use guide shoes for Ø 66", 72", 84", 96" OS Type Lead Size: OS 98					

P-518 120" LARGE DIAMETER DRIVE PLATES					
	410456	120" Drive Plates Diameter	1	61,001	steel cable 2
	500335	striker plate, Ø 37" x 12"	1	3,080	(910-CBCP-12MM) cable clamp 2
	500165	aluminium cushion, Ø 37" x 1/2"	3	159 (for 3)	
	500115	phenolic cushion, Ø 37" x 1"	2	142 (for 2)	
					Total: 64,382 lbs
Pipe Pile Size: Up to 120"Ø Use guide shoes for Ø 84", 96", 98", 108",114" OS Type Lead Size: OS 120					

P-529 120" LARGE DIAMETER STEP DRIVE PLATES					
	410464	120" Step Drive Plates Diameter	1	74,621	steel cable 2
	500335	striker plate, Ø 37" x 12"	1	3,080	(910-CBCP-12MM) cable clamp 2
	500165	aluminium cushion, Ø 37" x 1/2"	3	159 (for 3)	
	500115	phenolic cushion, Ø 37" x 1"	2	142 (for 2)	
					Total:78,002 lbs
Pipe Pile Size: Up to 120"Ø OS Type Lead Size: 10120					

All weights are approximated

A104-48 Neck Adapter for 78 inch		
	48078	24,000 lbs approx.
Pipe Pile Size: 78", 72", 66", 60", 54"		

Followers (standard)



All weights are approximated

18 inch Followers			
	#8001425	3,293 lbs approx.	18" X 10 FT FOLLOWER PIPE ASSEMBLY
	#8001426	6,586.34 lbs approx.	18" X 20 FT FOLLOWER PIPE ASSEMBLY
	#8001427	9,331.49 lbs approx.	18" X 30 FT FOLLOWER PIPE ASSEMBLY
	#8001428	12,076.64 lbs approx.	18" X 40 FT FOLLOWER PIPE ASSEMBLY

18 inch Follower Lift Sleeve w/ Guiding			
	#8001429		U-26
	#8000795	451.98 lbs. approx.	U-32
	#8001400	582.73 lbs approx.	U-42
	#8001430		U-48

18 inch Follower Lift Sleeve Non Guiding			
	#8000890	302.05 lbs. approx.	18"

All weights are approximated

P-510 24" CONCRETE HELMET ASSEMBLY					
	#	Assembly	Qty	Weight lbs. approx.	Accessories
	500024-B	24"sq Concrete Helmet	1	7,056 lbs	steel cable 2
	500315	striker plate 23" x 10"	1	974	(910-CBCP-12MM) cable clamp 2
	500159	aluminium cushion 23" x ½"	3	63 (for 3)	
	500109	phenolic cushion 23" x 1"	2	56 (for 2)	
Square Pile Size: 24" U-Lead Guiding: 32.5"x 8",42.5"x 8"			Total weight approx. = 8,149 lbs		
P-511 30" CONCRETE HELMET ASSEMBLY					
	500030-C	30"sq Concrete Helmet	1	12,566	steel cable 2
	500330	striker plate, Ø 27" x 12"	1	1,532	(910-CBCP-12MM) cable clamp 2
	500160	aluminium cushion Ø 27" x ½"	3	84 (for 3)	
	500110	phenolic cushion, Ø 27" x 1"	2	76 (for 2)	
Square Pile Size: 30" U-Lead Guiding: 42.5" x 8", 48.5" x 8"			Total weight approx. = 14,257 lbs		
P-512 36" CONCRETE HELMET ASSEMBLY					
	500036-C	36" sq Concrete Helmet	1	10,317	steel cable 2
	500330	striker plate, Ø 27" x 12"	1	1,532	(910-CBCP-12MM) cable clamp 2
	500160	aluminium cushion, Ø 27" x ½"	3	84 (for 3)	
	500110	phenolic cushion, Ø 27" x 1"	2	76 (for 2)	
Square Pile Size: 36" U-Lead Guiding: 42.5" x 8",48.5" x 8"			Total weight approx. = 12,009 lbs		



All weights are approximated

P-513 21" UNIVERSAL HELMET ASSEMBLY

	#	Assembly	Qty	Weight lbs. approx.	Accessories
	500000	21" Universal Helmet	1	904	steel cable 2
	500307	striker plate, Ø 17"x 6"	1	330	(910-CBCP-12MM) cable clamp 2
	500157	aluminium cushion, Ø 17" x ½"	2	22 (for 2)	
	500107	phenolic cushion, Ø 17" x 1"	1	12	
					Total approx. : 1,268 lbs

Pile Type: Steel beams: 8", 10", 12" Steel Pipe Ø: 10", 12", 14" **U-Lead Guiding:** 21" x 8"

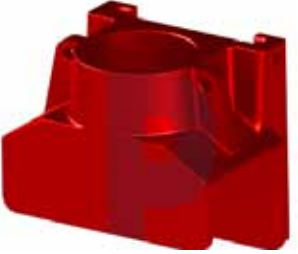
*All weights are approximated

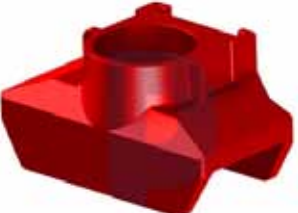
P-505					
	#	Assembly	Qty	*Weight lbs.	Accessories
	500013	Sheet Pile Helmet	1	1,360	steel cable 2
	500301	striker plate, sq 13"x4"	1		910-CBCP-12MM cable clamp 2
	500151	aluminium cushion sq 13"x1/2"	3	33 (for 3)	210-41981 clip 1-1/4" 1
	500101	phenolic cushion sq 13"x1"	2	24 (for 2)	special clamp 210-41766 1
Pile Size: 30.5"x 13.25", Sheet Piles, using Diesel Hammer up to D19-42					
P-524					
	500013 HD1	Sheet Pile Helmet	1	1,900	steel cable 2
	500300	Striker plate, Ø 13"x4"	1		cable clamp 2 910-CBCP-12MM
	500172	aluminium cushion Ø 13"x1/2"	3	33 (for 3)	clip 1-1/2" 1 210-41980
	500122	phenolic cushion Ø 13"x1"	2	24 (for 2)	special clamp 1 210-41949
Pile Size: 30" x 12.5", Sheet Piles, using Diesel Hammer larger then D19-42					
P-525					
	500013 HD2	Sheet Pile Helmet	1	3,280	steel cable 2
	500307	striker plate, Ø 17"x6"	1	330	cable clamp 2 910-CBCP-12MM
	500157	aluminium cushion Ø 17"x1/2"	3	33 (for 3)	clip 1-1/2" 1 210-41980
	500107	phenolic cushion Ø 17"x1"	2	24 (for 2)	special clamp 1 210-41949
Pile Size: 38" x 14.5", Sheet Piles, using Diesel Hammer larger then D19-42					
P-526					
	500013-HD5	Sheet Pile Helmet	1	4,380	steel cable 2
	500308-HD	striker plate, Ø 19"x7"	1		cable clamp 2 910-CBCP-12MM
	500158	aluminium cushion Ø 19"x1/2"	3		clip 1-1/2" 1 210-41980
	500108	phenolic cushion Ø 19"x1"	2		special clamp 1 210-41949
Pile Size: 52" x 19", Sheet Piles, using Diesel Hammer larger then D19-42					

*All weights are approximated

P-520					
	#	Assembly	Qty.	*Weight lbs	Accessories
	500012-HD	12" Square Concrete Helmet	1	1250	steel cable 2
	500300	striker plate, Ø 13" x 4"	1		cable clamp 2 910-CBCP-12MM
	500172	aluminium cushion Ø 13" x 1/2"	3	33 (for 3)	clip 1-1/2" 1 210-41980
	500122	phenolic cushion Ø 13" x 1"	2	24 (for 2)	special clamp 1 210-41949

Pile Size: square 12", **Concrete Piles, Pipe Piles, and H-beams, using Diesel Hammer larger then D19-42**

P-521					
	#	Assembly	Qty.	*Weight lbs	Accessories
	500014 HD	14" Square Concrete Helmet	1	1400	steel cable 2
	500300	striker plate, Ø 13" x 4"	1		cable clamp 2 910-CBCP-12MM
	500172	aluminium cushion Ø 13" x 1/2"	3	33 (for 3)	clip 1-1/2" 1 210-41980
	500122	phenolic cushion Ø 13" x 1"	2	24 (for 2)	special clamp 1 210-41949

Pile Size: square 14", **Concrete Piles, Pipe Piles, and H-beams, using Diesel Hammer larger then D19-42**

P-522					
	#	Assembly	Qty.	*Weight lbs	Accessories
	500016 HD	16" Square Concrete Helmet	1	1,700	steel cable 2
	500307	striker plate, Ø17"x6"	1	330	cable clamp 2 910-CBCP-12MM
	500157	aluminium cushion Ø17"x1/2"	3	33 (for 3)	clip 1-1/2" 1 210-41980
	500107	phenolic cushion Ø17"x1"	2	24 (for 2)	special clamp 1 210-41949

Pile Size: square 16", **Concrete Piles, Pipe Piles, and H-beams, using Diesel Hammer larger then D19-42**

P-523					
	#	Assembly	Qty.	*Weight lbs	Accessories
	500020 HD	20" Square Concrete Helmet	1	2,150	steel cable 2
	500307	striker plate, Ø17"x6"	1	330	cable clamp 2 910-CBCP-12MM
	500157	aluminium cushion Ø17"x1/2"	3	33 (for 3)	clip 1-1/2" 1 210-41980
	500107	phenolic cushion Ø17"x1"	2	24 (for 2)	special clamp 1 210-41949

Pile Size: square 20", **Concrete Piles, Pipe Piles, and H-beams, using Diesel Hammer larger then D19-42**